

Housing for elderly people in Huningue

Huningue, France

Dominique Coulon & associés

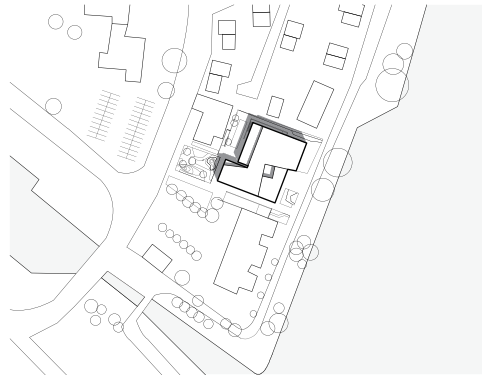



Site Plan

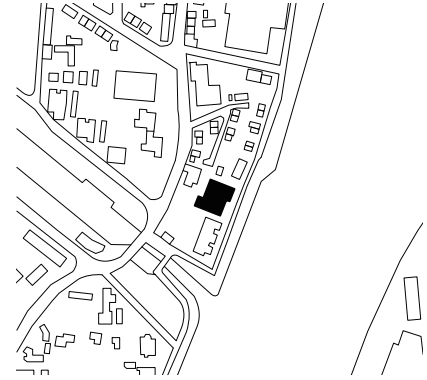

Location



Design Dominique Coulon & associés_Dominique Coulon, Olivier Nicollas, Gautier Duthoit **Design Team** Javier Gigosos-Ruipérez, Diego Bastos-Romero **Construction Site Supervision** Olivier Poulat **Location** 41 Rue du Maréchal Joffre, 68330 Huningue, France **Use** Housing for elderly people **Area** 3,932m² **Structural Engineer** Batiserf Ingénierie **Landscape** Bruno Kubler **Client** Ville de Huningue **Photo** Eugeni Pons

디자인 도미니크 쿨롱 & 어쏘시에스_도미니크 쿨롱, 올리비에 니콜라스, 고티에 두토이트 **디자인팀** 하비에르 기고소스-루이페레즈, 디에고 바스토스-로메로 **현장감독** 올리비에 풀랏 **위치** 프랑스 유낭그 **용도** 노인들을 위한 주거 **면적** 3,932m² **구조기술** 바티세프 잉게니에리 **조경** 브루노 쿠브러 **발주처** 빌레 드 유낭그 **사진** 유제니 폰즈

유낭그의 노인들을 위한 주거

노인들을 위한 이 주택은 라인강 둑 위에 지어졌다. 우리는 특별한 부지를 일반 부지처럼 바꾸었으며 강 쪽으로 향하는 현관을 냈다. 그 결과, 입주자들은 보트가 지나가는 것을 즐길 수 있게 됐다. 이 프로젝트는 2,550m² 규모의 주거지와 레스토랑, 컴퓨터실, 취미 공방, 정원, 폐탕크용 공간을 설계하는 것이었다.

이 프로젝트의 모든 것은 입주자들의 관계를 구축하는 데 중점을 뒀다. 단체 주거 공간은 천연광을 사용해 가능한 한 아늑한 분위기를 풍길 수 있게 했다. 우리는 교환과 사회적 상호작용을 장려할 수 있는 장소를 설계했다. 그리고 건물 내 동선 사이 사이에 만남을 위한 공간을 끼워 넣었다.

건물 중간에 계단을 배치해 입주자들이 서로 만날 수 있게 했다. 그리고 중앙 공간을 넓혀 이동성을 크게 만들었다. 위층으로 올라가면 남향 파티오에서 빛이 들어와 건물의 중앙까지 따뜻하게 만들어준다. 내부를 흰색으로 꾸며 부유하는 느낌을 강조했으며 빈 공간을 해체하고 전체적으로 약간 특이한 느낌을 연출했다.

붉은색 콘크리트와 테라코타, 나무 자재로 따뜻한 분위기를 자아냈다. 그리고 건물 외부의 모든 면은 벽돌로 둘렀다. 하지만 불규칙하고 때로 잘못된 형태도 있는 크래프트 벽돌을 사용해 일반적인 느낌을 주지 않았다. 소박한 항구 도시 배경을 강조한 건물은 그 자체가 라인강 역사와 이어지고 있다.





This housing for elderly people is located on the banks of the Rhine. The exceptional situation of the site allowed us to turn the common areas and the hall towards the river: the residents can enjoy the choreography of passing boats. The programme consists of twenty-five fifty-square-meter homes, a restaurant in three sections, a computer room, a hobby workshop, a vegetable garden and a petanque field.

Everything is organised to foster relations among the residents. Collective living spaces are as generous as possible, with abundant natural light. We have designed places that encourage exchanges and social interaction. Encounter-inviting events and sequences punctuate the routes.

The staircase stands at the centre of the building, rendering it unavoidable. In combination with the wide central space, it invites mobility. Upstairs, the patio brings light from the south into the heart of the building. The white volume inside seems suspended; it deconstructs the empty space and lends a certain strangeness to the whole.

Red concrete, terracotta and wood produce a benevolent atmosphere. Outside, the building is enveloped in brick on all sides. We selected a craft brick that is non-standard, irregular and occasionally misshapen. The walls catch the light; by emphasising its rustic port setting, the building connects itself to the history of the Rhine.

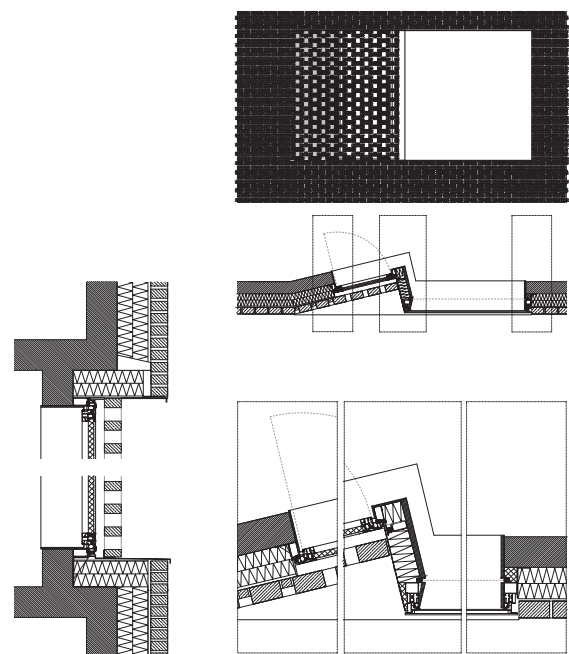

Detail



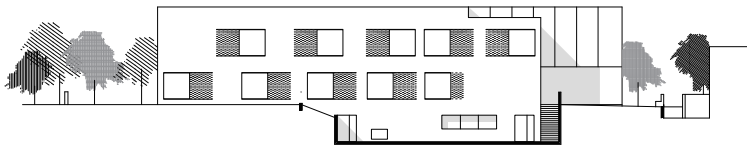

Elevation

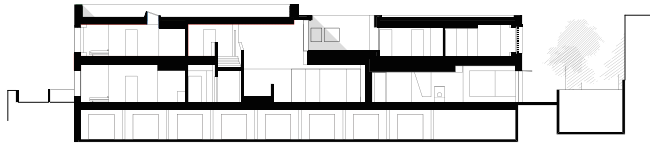

Section

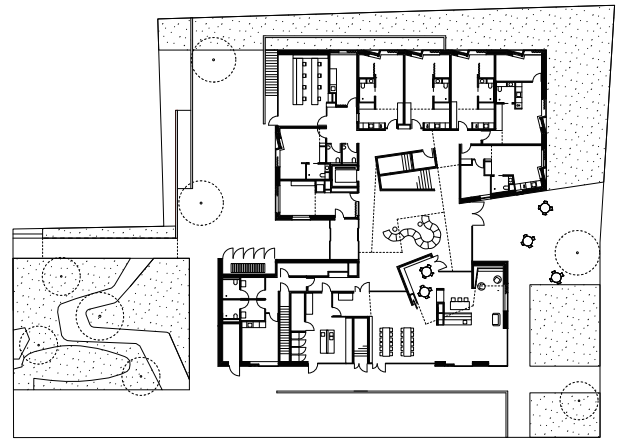

Floor Plan

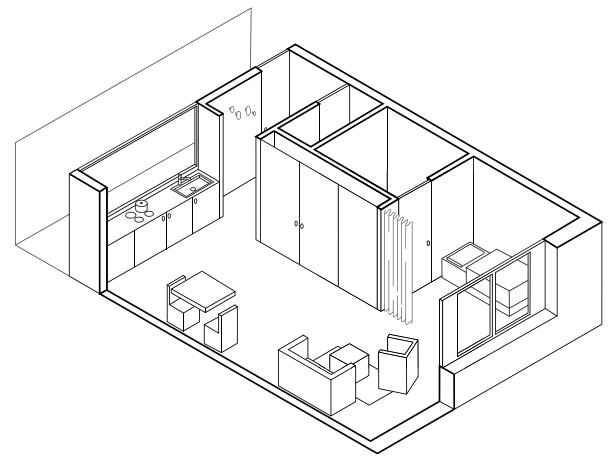

Standard Accomodation

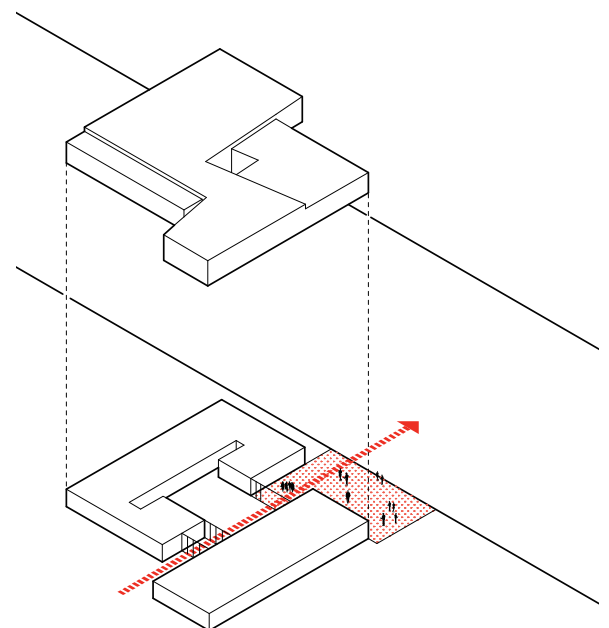

Schema



